

STANDARD EQUIPMENT

ENGINE

- ▣ Engine, SAA6D140E-5, diesel engine with turbocharger and intercooler
- ▣ Automatic engine deceleration
- ▣ Auto Idle Stop (AIS)
- ▣ Batteries (2x12V - 160Ah)
- ▣ Starting motor (24V - 11kW), 60 amp alternator
- ▣ Removable clean-out screen for radiator
- ▣ Automatic engine shut-off for low engine oil pressure
- ▣ Engine oil pan drain valve
- ▣ Double element air cleaner x 2
- ▣ Pre-air cleaner
- ▣ Fuel pre-filter
- ▣ Corrosion register

CONTROL

- ▣ Working mode selector (H-mode and S-mode)

SWING SYSTEM & TRAVEL SYSTEM

- ▣ Swing rebound prevention system
- ▣ Straight propel system
- ▣ Two-speed travel with automatic shift down
- ▣ Sealed & lubricated track links
- ▣ Grease-type track adjusters
- ▣ Automatic swing brake

HYDRAULIC

- ▣ Arm regeneration system
- ▣ Auto warm up system
- ▣ Aluminum hydraulic oil cooler
- ▣ Drain filter

MIRRORS & LIGHTS

- ▣ Three rearview mirrors
- ▣ Six front working lights

CAB & CONTROL

- ▣ Two control levers, pilot-operated
- ▣ Tow eyes
- ▣ Horn, electric
- ▣ Integrated left-right slide-type control box
- ▣ Cab, all-weather sound suppressed type
- ▣ Ashtray
- ▣ Cigarette lighter
- ▣ Cab light (interior)
- ▣ Coat hook
- ▣ Luggage tray
- ▣ Large cup holder
- ▣ Detachable two-piece floor mat
- ▣ Double slide seat
- ▣ 7-way adjustable suspension seat
- ▣ Retractable seatbelt
- ▣ Headrest
- ▣ Handrails
- ▣ Intermittent windshield wiper with double-spray washer
- ▣ Sunshade
- ▣ Skylight
- ▣ Tinted safety glass
- ▣ Pull-type front window and removable lower front window
- ▣ Easy-to-read multi-display monitor
- ▣ Automatic air conditioner
- ▣ Emergency escape hammer
- ▣ Rear view camera
- ▣ Cab guard

OPTIONAL EQUIPMENT

- ▣ 4.3 HD bucket
- ▣ 750 mm shoe
- ▣ Full track guide

Note: Standard and optional equipment may vary. Consult your KOBELCO dealer for specifics.

Excavator Remote Monitoring System

Remote Monitoring System is a satellite-based system for receiving machine information. Manage your machines anywhere in the world using the Internet. Location, workload and diagnostic data aid business operations.

Direct Access to Operational Status

Location Data

Accurate location data can be obtained even from sites where communications are difficult.

Operating Hours

A comparison of operating times of machines at multiple locations shows which locations are busier and more profitable.

Operating hours on site can be accurately recorded, for running time calculations needed for rental machines, etc.

Fuel Consumption Data

Data on fuel consumption and idling times can be used to indicate improvements in fuel consumption.

Graph of Work Content

The graph shows how working hours are divided among different operating categories, including digging, idling, traveling, and optional operations (N&B).



Maintenance Data and Warning Alerts

Machine Maintenance Data

Provides maintenance status of separate machines operating at multiple sites. Maintenance data is also relayed to KOBELCO service personnel, for more efficient planning of periodic servicing.

Security System

Engine Start Alarm

Sends a notification if the engine is started outside of pre-defined hours.

Area Alarm

Sends a notification if the machine leaves a pre-defined area.

Note: Remote monitoring system is not applicable in some area due to country regulation of the communication lines or availability of infrastructure.

Note: This catalog may contain attachments and optional equipment that are not available in your area. And it may contain photographs of machines with specifications that differ from those of machines sold in your areas. Please consult your nearest KOBELCO distributor for those items you require. Due to our policy of continuous product improvements all designs and specifications are subject to change without advance notice. Copyright by **KOBELCO CONSTRUCTION MACHINERY CO., LTD.** No part of this catalog may be reproduced in any manner without notice.

KOBELCO CONSTRUCTION MACHINERY CO., LTD.

5-15, Kitashinagawa 5-chome, Shinagawa-ku, Tokyo 141-8626 JAPAN
Tel: +81 (0) 3-5789-2146 Fax: +81 (0) 3-5789-2135
<https://www.kobelcocm-global.com>

Inquiries To:



■ Bucket Capacity:

4.3 – 5.1 m³ ISO heaped

■ Engine Power:

370 kW (503 PS)/1,800 min⁻¹{rpm}
(ISO14396)

■ Operating Weight:

80,500 kg – 81,700 kg

The Concept of Beautiful Performance.

The Power Wave of Change

When we set out to design our new hydraulic excavators, we kept our eyes on the big picture.

Of course we wanted machines with greater digging capacity.

But they also had to be fuel-efficient and economical, while imposing less of a burden on the local and global environments.

Applying our advanced technologies, we developed SK series, an entirely new kind of excavator that beautifully balances all the demands of today's construction industry.

Lean and efficient with capacity to spare, these sleek powerhouses bring a whole new style to the worksite while setting new standards for environmental responsibility.



Pursuing the "Three E's"

The Perfection of Next-Generation, Network Performance

Enhancement

Greater Performance Capacity

- New hydraulic circuitry minimizes pressure loss
- High-efficiency, electronically controlled
- Common Rail Fuel Injection Engine
- Powerful travel and arm/bucket digging force

Economy

Improved Cost Efficiency

- Advanced power plant that reduces fuel consumption
- Easy maintenance that reduces upkeep costs
- High structural durability and reliability that retain machine value longer

Environment

Features That Go Easy on the Earth

- Auto Idle Stop as standard equipment
- Noise reduction measures (with improvement of the sound quality) minimize noise and vibration

Efficient Performance!



Great Productivity and Low Fuel Costs

Advanced hydraulic technology keeps fuel costs low matches pump output with a high efficiency engine that conserves fuel, resulting in great productivity and low fuel costs.

High Swing Torque

The use of high swing torque delivers a smoother, stronger and swing for faster, more efficient cycle times. It also provides plenty of start-up swing power for safe operation on slopes.

Swing torque: **268 kN·m**

Swing speed: **8.4 min⁻¹**

Plenty of Digging Force

Digging is smoother than ever with the newly shaped bucket.

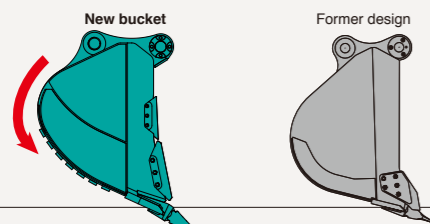

The sharp edge penetrates more easily.

Max. bucket digging force: **432 kN {44.1 tf}**

Max. arm crowding force: **351 kN {35.8 tf}**

Strongest Travel Power and Drawbar Pulling Force in Its Class!

The large-capacity motor delivers the strongest travel power and drawbar pulling force in the machine's class, making it ideal for large civil engineering projects, rock-crushing work, and other power-intensive applications.

Travel speed: **4.2/2.7 km/h**

Drawbar pulling force: **637 kN {65.0 tf}**

Excellent Lateral Stability

The SK850LC has the widest crawlers in its class for outstanding lateral stability. Fitted with a 5.1 m³ bucket, it can safely lift a maximum of 9.25 tons over the side, the most in its class. (Condition: rating over side, 10.5 m reach at G. L., 750 mm shoe)

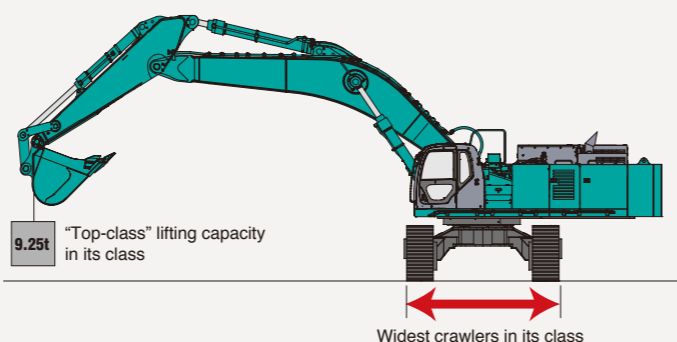

9.25t "Top-class" lifting capacity in its class

Widest crawlers in its class

Extended Continuous Operation (Large-Capacity Fuel Tank)

The large-capacity fuel tank, combined with higher fuel efficiency, enables the SK850LC to operate continuously for twelve hours.



* Continuous digging in S mode. Length of continuous operation will vary with type of operation and load on engine.

New Cooling System

The cooling fan changes speed automatically according to the temperature of the cooling water in the radiator. This prevents overheating when the water temperature rises, allowing continuous, high-load operation. When the water temperature falls, the cooling system operates very quietly, contributing to both low noise and low fuel consumption.

The patented Maintenance Walk as air duct is another KOBELCO innovation that further enhances the cooling system's effectiveness.

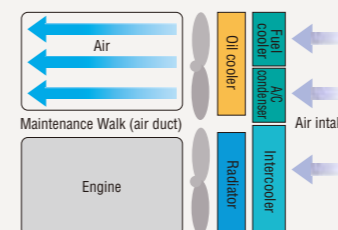

Light-Touch Levers

The operating levers are light and easy to move, reducing operator fatigue over long hours of operation.

Seamless, Smooth Combined Operations

The GEOSPEC machines have inherited the various systems that make inching and combined operations easy and accurate, with further refinements that make a good thing even better. Leveling and other combined operations can be carried out with graceful ease.

- The arm cylinder heads are arranged in a double row to reduce pressure loss in the return line and enhance fuel efficiency. The double row also enables faster arm retraction for better productivity.

- Electronic active control system
- Arm regeneration system
- Boom lowering regeneration system
- Variable swing priority system
- Swing rebound prevention system

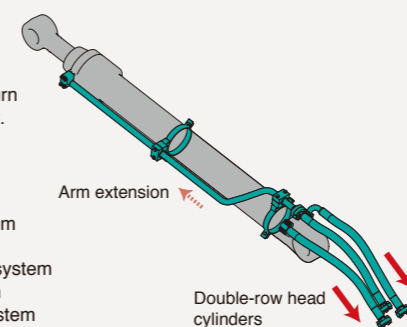

1 NEXT-3E Technology New Hydraulic System

Rigorous inspections for pressure loss are performed on all components of the hydraulic piping, from the first spool of the control valve to the connectors. This regimen, combined with the use of a new, high-efficiency pump, cuts energy loss to a minimum.

2 NEXT-3E Technology Next-Generation Electronic Engine Control

The high-pressure, common-rail fuel-injection engine features adjustable control to maximize fuel efficiency and provide powerful medium/low-speed torque. The result is a highly fuel-efficient engine.



3 NEXT-3E Technology Total Tuning Through Advanced ITCS Control

The next-generation engine control is governed by a new version of ITCS, which responds quickly to sudden changes in hydraulic load to ensure that the engine runs as efficiently as possible with a minimum of wasted output.

ITCS ITCS (Intelligent Total Control System) is an advanced, computerized system that provides comprehensive control of all machine functions.

Simple Select: Two Digging Modes

- H-Mode:** For heavy duty when a higher performance level is required.
- S-Mode:** For normal operations with lower fuel consumption.

The Value and Quality of Sturdy Construction!

Large excavators are often used on steep, rough roads in mountains and quarries where they are expected to operate continuously for many hours at a time. They have to be durable. The high-strength construction of the SK850LC has already been proven through use in large KOBELCO building demolition machines, and has been carefully scrutinized through 30,000 hours of additional durability testing. It has the tough durability required in all of its components, including the upper and lower body and attachment.

Stable Attachment Strength

All components are either cast or forged, with HD type boom and arm provided as standard equipment. The balanced design ensures excellent durability even when using a large bucket, providing highly reliable attachment strength.

Upper Frame with High Structural Strength

FEM* analysis was used to determine the best materials, select the steel plate, and create a high-strength design resulting in an upper frame that features high structural strength.

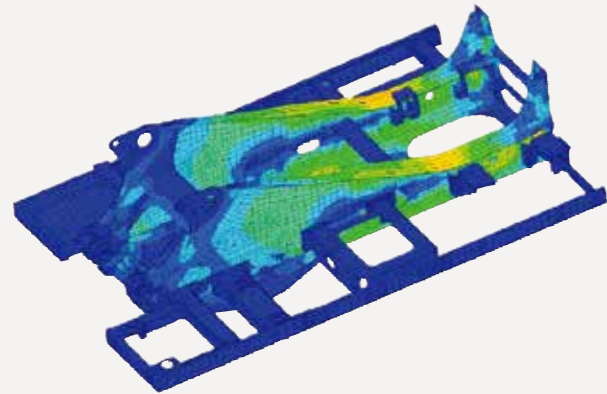

*FEM (Finite Element Method)
Method of numerical analysis used in structural mechanics

Strong Carbody Structure

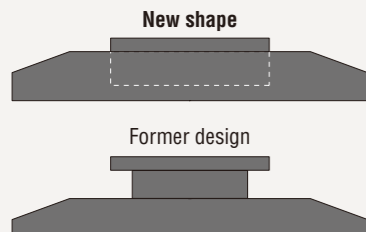

Strength is especially crucial in the carbody. The swing mechanism on the SK850LC is mounted without a column, thereby increasing the carbody's cross-section size for greater strength.

Large Components Used in the Crawler Frame

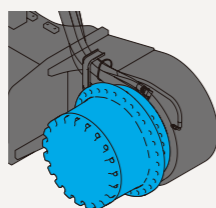

Reinforced Travel Reduction Gear Cover
A high-strength protective cover enhances the durability of the travel reduction gear.

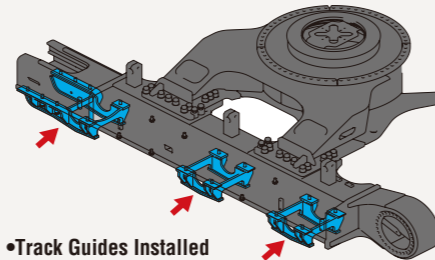

Track Guides Installed in Three Places
Track guides installed in three different places improve travel stability and help prevent the crawlers from coming off the rollers. Full track guide can be installed as an option.

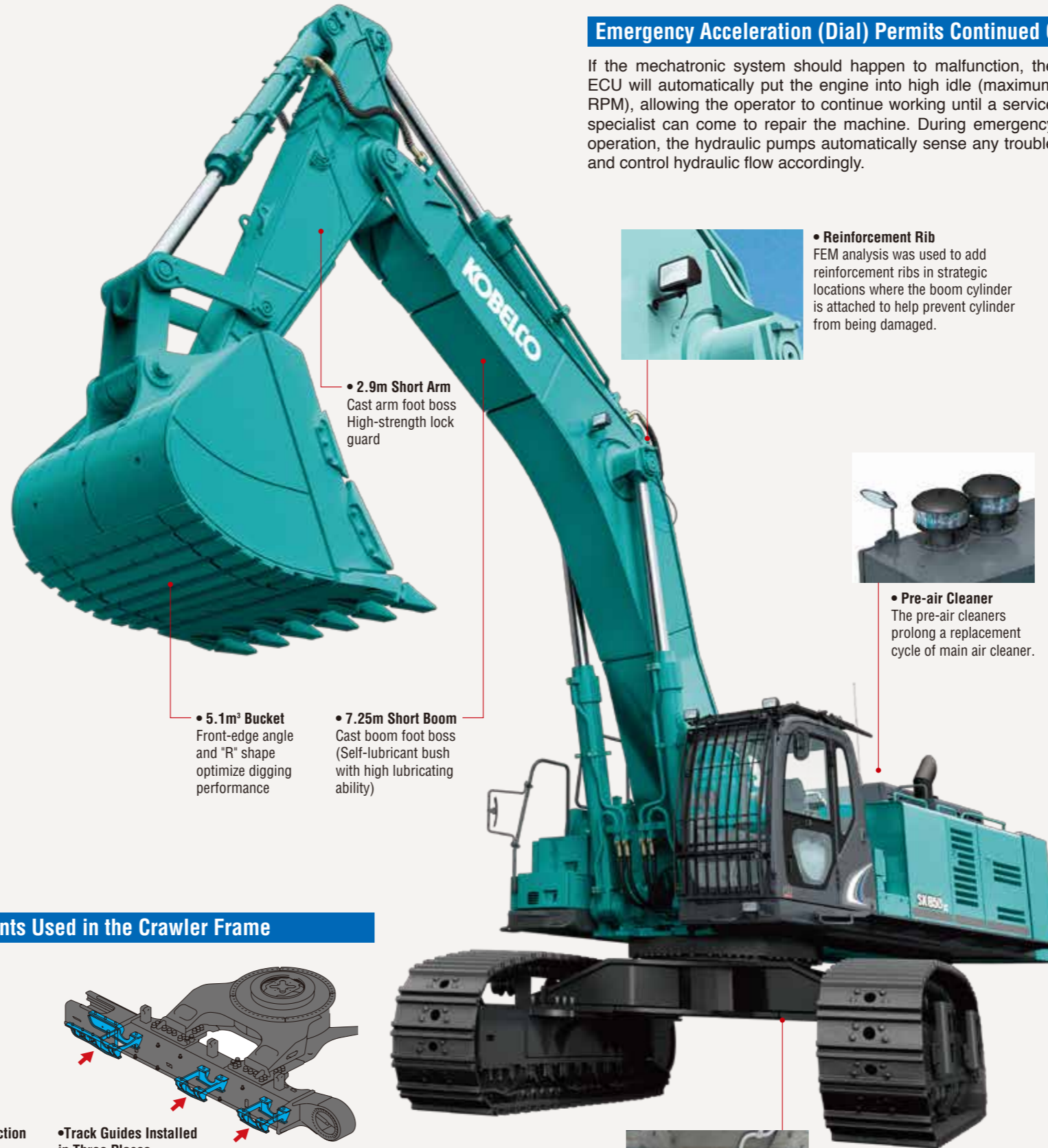

2.9m Short Arm
Cast arm foot boss
High-strength lock guard

5.1m³ Bucket
Front-edge angle and "R" shape optimize digging performance

7.25m Short Boom
Cast boom foot boss (Self-lubricant bush with high lubricating ability)

Reinforcement Rib
FEM analysis was used to add reinforcement ribs in strategic locations where the boom cylinder is attached to help prevent cylinder from being damaged.

Pre-air Cleaner
The pre-air cleaners prolong a replacement cycle of main air cleaner.

Emergency Acceleration (Dial) Permits Continued Operation in the Unlikely Event of Malfunction

If the mechatronic system should happen to malfunction, the ECU will automatically put the engine into high idle (maximum RPM), allowing the operator to continue working until a service specialist can come to repair the machine. During emergency operation, the hydraulic pumps automatically sense any trouble and control hydraulic flow accordingly.

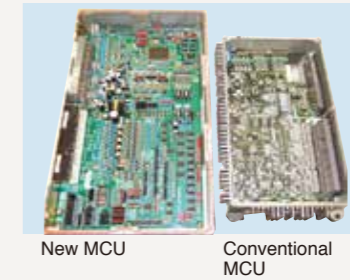
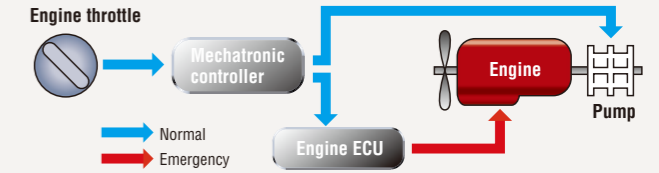

Newly designed MCU

- Vertical alignment and sealed cover gives better protection from water and dust
- Integration in base plate boosts assembly quality
- Reliable fixture to base plate

Countermeasures Against Electrical System Failure

All elements of the electrical system, including controller, have been designed for enhanced reliability.

Excellent Transportability

Counterweight Device

The counterweight device operates both vertically and horizontally for safe and efficient onsite assembly and disassembly.

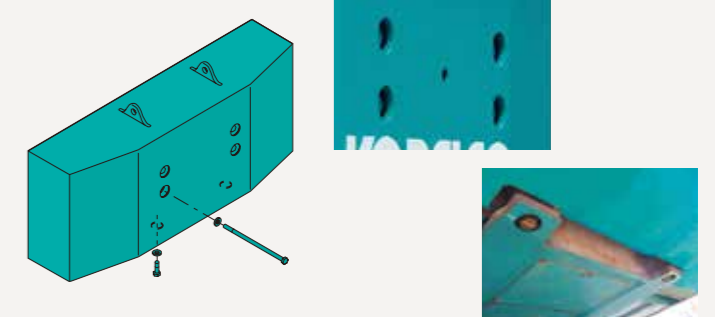

Four Disassembly and Transport Patterns

The SK850LC can be disassembled and transported in four different ways, including: no counterweight, with boom attached; main body only; main body without crawler frame; etc.

Retractable Track gauge

The variable gauge crawler extends the crawlers to a maximum width of 4,200 mm (with 650 mm shoes) for extremely stable operation, and retracts them to a compact minimum width of 3,400 mm for easier transport.

Full Track Guide (Optional)

Full track guide can be installed as an option.



Easily detachable bolt-on type Undercover for upper carriage

Easy Maintenance That Supports Large-Scale Operation!

Daily maintenance checks are essential for the successful operation of large, continuously operating excavators. Inspections and maintenance must be quick and easy to maximize productivity. With its maintenance walk, the SK850LC provides easy access to essential components and systems so that more time is spent on the job.



Photos: Specifications may vary in your areas.

Maintenance Walk Serves as an Air Duct During Operation

Kobelco's unique design covers the maintenance walk to create an air duct that helps to keep the radiator cool during machine operation.

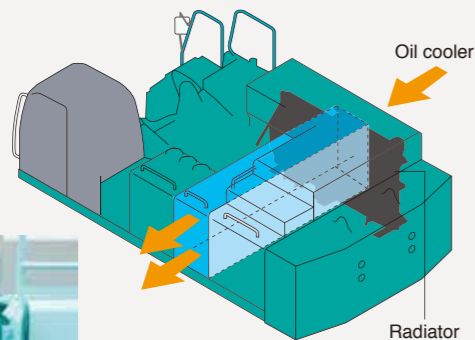

Easy Inspection of Swing Bearing, Gear and Bolt

A small access port is located in front of the upper frame to make it easier to inspect the swing bearing, gear and bolt.

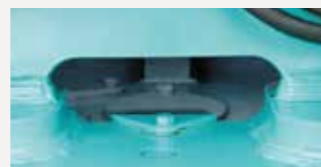

Auto-Coil Grease Gun Holder

- Grease tank
- Lubrication hose
- Fuel tank drain valve



- Air cleaner



Bolted Double Service Doors Open and Close Easily

- Intercooler
- A/C condenser
- Fuel cooler
- Radiator
- Oil cooler



Around the engine compartment



- Fuel filter



- Fuel pre-filter with water separator



- Engine oil drain valve



- Engine oil filter

Simple Filtration

- Hydraulic oil filter x 3

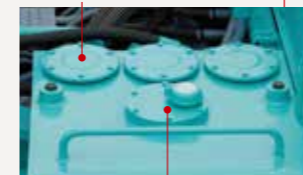

- Suction filter



- Battery



- Drain filter



- Large tool box



- Cat walk

High-Grade Fuel Filter with Superior Filtration Performance



The high-performance, large capacity filter is designed specially for the common-rail fuel injection engine.

Highly Durable Super-fine Filter



- Super-fine filter

The high-capacity hydraulic oil filter incorporates glass fiber with superior cleaning power and durability. With a replacement cycle of 1,000 hours and a construction that allows replacement of the filter element only, it's both highly effective and highly economical.

Long-life hydraulic oil filter: **1,000 hours**

More Efficient Maintenance Inside the Cab

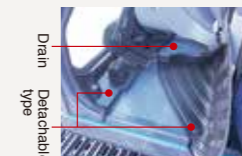

- Detachable two-piece floor mat with handles for easy removal. A floor drain is located under the mat.



- Easy-access fuse box. More finely differentiated fuses make it easier to locate malfunctions.



- Air conditioner filter can be easily removed without tools for cleaning.

Monitor Display with Essential Information for Accurate Maintenance Checks



- Displays only the maintenance information that's needed, when it's needed.
- Self-diagnostic function that provides early-warning detection and display of electrical system malfunctions.
- Record previous breakdowns, including irregular and transient malfunctions.

Designed from the Operator's Point of View



Plenty of Foot Room

Comfortable 1,005 mm-Wide Cab.

Wide Field of View Liberates the Operator



The front field of view easily clears ISO standards, while the peripheral view reduces blind spots to a minimum.

- Along wiper covers a wide area for a broad view in bad weather.
- Backmirrors provide a safe view of the rear.
- Reinforced green glass windows meet European standards.

Wide-Access Cab Ensures Smooth Entry and Exit

The left control box lifts up with the safety lock lever to add 10° to the cab entry angle for easy entrance and exit.



Reduced Vibration for Fatigue-Free Operation

The rigid cab construction and liquid-filled viscous cab mounts minimize cab vibration. In addition, the use of new lower rollers on the crawlers cuts travel vibration in half compared with previous models.

Creating a Comfortable Operating Environment



- Seat can be reclined to horizontal position



- Double slide and suspension seat



- Powerful automatic air conditioner



- Spacious luggage tray



- One-touch lock release simplifies opening and closing the front window



- Large cup holder

Designed for the Environment and the Future!

Auto Idle Stop Provided as Standard Equipment

This function saves fuel and cuts emissions by shutting down the engine automatically when the machine is on stand by. It also stops the hourmeter, which helps to retain the machine's asset value.

Automatic Acceleration/Deceleration Function Reduces Engine Speed

Engine speed is automatically reduced when the control lever is placed in neutral, effectively saving fuel and reducing noise and exhaust emissions. The engine quickly returns to full speed when the lever is moved out of neutral.

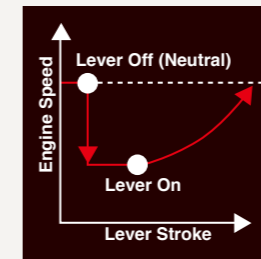

Low Noise Level and Mild Sound Quality

The electronically controlled common-rail engine has a unique fuel injection system that runs quietly. Also, the hydraulic pumps have been redesigned to produce a more pleasant sound during pressure relief. In short, it meets all requirements cited in EU stage II.

Meets EMC (Electromagnetic Compatibility) Standards in Europe.

Measures have been taken to ensure not to cause electromagnetic interference.

Imagining Possible Scenarios and Preparing in Advance

Safety Features That Take Various Scenarios into Consideration

Top Guard

Level2 FOPS Guard (ISO 10262) is fitted as standard.



Rear View Camera

A rear view camera is installed as standard to simplify checking for safety behind the machine. The picture appears on the color monitor.

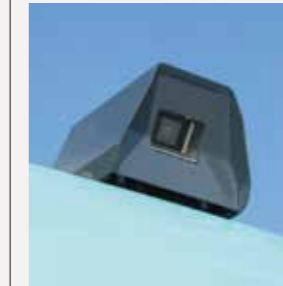

- Thermal guard prevents contact with hot components during engine inspections
- Retractable seatbelt requires no manual adjustment
- Hammer for emergency exit



Photos: Specifications may vary in your areas.



Engine

Model	KOMATSU SAA6D140E-5
Type	Direct injection, water-cooled, 4-cycle electrically-controlled common rail system type diesel engine with turbocharger, intercooler
No. of cylinders	6
Bore and stroke	140 mm X 165 mm
Displacement	15.24 L
Rated power output	370 kW (503 PS) SAE NET at 1,800 min ⁻¹ {rpm} (ISO14396: 2002)
Max. torque	2,197 N·m at 1,350 min ⁻¹ {rpm}
Electrical system	D.C. 24V
Starter	24 V, 11 kW
Alternator	60 AMP
Batteries	2 X12 V – 160Ah



Hydraulic System

Pump	
Type	Two variable displacement pumps + 1 gear pump
Max. discharge flow	2 X504 L/min, 1 X30 L/min
Relief valve setting	
Boom, arm and bucket	33.0 MPa {337 kgf/cm ² }
Travel circuit	33.0 MPa {337 kgf/cm ² }
Swing circuit	30.0 MPa {306 kgf/cm ² }
Control circuit	5.0 MPa {50 kgf/cm ² }
Pilot control pump	Gear type
Main control valves	8-spool
Oil cooler	Air cooled type



Boom, Arm & Bucket

Boom cylinders	210 mm X 1,800 mm
Arm cylinder	220 mm X 2,175 mm
Bucket cylinder	200 mm X 1,570 mm

7.25 m Short Boom	2.9 m Short Arm	5.1 m ³ Bucket	4.3 m ³ Bucket
Weight: 10,040 kg	Weight: 4,130 kg	Weight: 5,090 kg	Weight: 4,060 kg

Application		Mass Excavator		
Bucket capacity	ISO heaped	m ³	5.1	4.3
Opening width	With side cutter	mm	2,380	2,000
No. of bucket teeth			6	5
Weight		kg	5,090	4,060
Combinations	2.9 m short arm		○	○

○ Recommend



Travel System

Travel motors	2 X axial-piston motor, two-step motors
Travel brakes	Hydraulic disc brake
Parking brakes	Oil disc brake per motor
Travel shoes	51 each side
Travel speed	4.2/2.7 km/h
Drawbar pulling force	637 kN {65,000 kgf} (J1309)
Gradeability	70 % (35°)



Cab & Control

Cab	
All-weather, sound-suppressed steel cab mounted on the silicon-sealed viscous mounts and equipped with a heavy, insulated floor mat.	
Control	
Two hand levers and two foot pedals for travel	
Two hand levers for excavating and swing	
Electric rotary-type engine throttle	



Swing System

Swing motor	Axial-piston motor
Brake	Hydraulic; locking automatically when the swing control lever is in the neutral position
Parking	Hydraulic disc brake
Swing speed	8.4 min ⁻¹ {rpm}
Swing torque	268 kN·m



Refilling Capacities & Lubrications

Fuel tank	960 L
Cooling system	76 L
Engine oil	58 L
Travel reduction gear	2 X22 L
Swing reduction gear	2 X21.5 L
Hydraulic oil tank	473 L tank oil level 851 L hydraulic system



Dimensions

Application		Mass Excavator	
Arm length		2.9 m	
Boom length		7.25 m	
A	Overall length	13,590	
B	Overall height (to top of boom)	4,880	
C	Overall width	with 650 mm shoe	Extended 4,200 Retracted 3,400
		with 750 mm shoe	Extended 4,300 Retracted 3,500
	C'	Overall width	Extended 4,440 Retracted 3,640
		D	Overall height (to top of cab)
E	Ground clearance of rear end*	1,560	
F	Ground clearance*	850	
F'	Ground clearance*	520	
G	Tail swing radius	4,600	
G'	Distance from center of swing to rear end	4,480	
H	Tumbler distance	5,140	
I	Overall length of crawler	6,380	
J	Track gauge	with 650/750 mm shoe	Extended 3,550 Retracted 2,750
		K	Shoe width
L	Overall width of upperstructure	3,350	
L'	Overall width of upperstructure	3,980	
M	Overall length of upperstructure	6,360	

*Without including height of shoe lug.

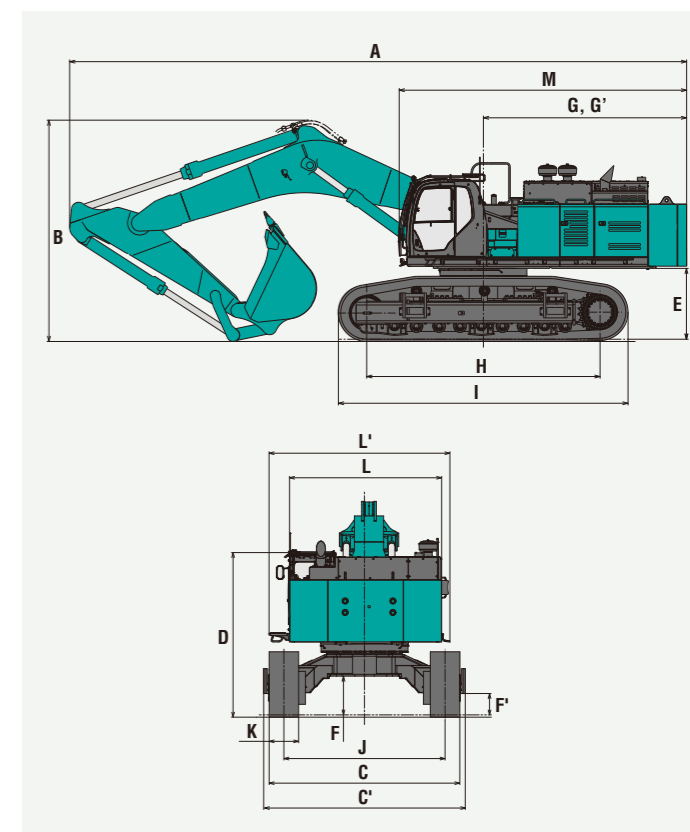

Operating Weight & Ground Pressure

Mass Excavator Application (With 7.25 m short boom, 2.9 m short arm, and 5.1 m³ bucket)

		Triple grouser shoe (even height)	
Shoe width	mm	650	750
Overall width of lower structure	mm	4,440	4,440
Operating weight	kg	80,500	81,100
Operating weight with full truck guide	kg	81,000	81,700
Ground pressure	kPa	109	95
Ground pressure with full truck guide	kPa	110	96



Working Ranges

Application		Mass Excavator
a	Max. digging reach	12.45
b	Max. digging reach at ground level	12.13
c	Max. digging depth	7.38
d	Max. digging height	11.69
e	Max. dumping clearance	7.77
f	Min. dumping clearance	3.66
g	Max. vertical wall digging depth	4.42
h	Min. swing radius	5.47
h'	Height at min. swing radius	10.24
i	Horizontal digging stroke at ground level	4.37
j	Digging depth for 2.4 m (8') flat bottom	7.23
Bucket capacity ISO heaped m ³		5.1

Digging Force (ISO 6015)

		Unit: kN (kgf)
Bucket digging force		432
Arm crowding force		351

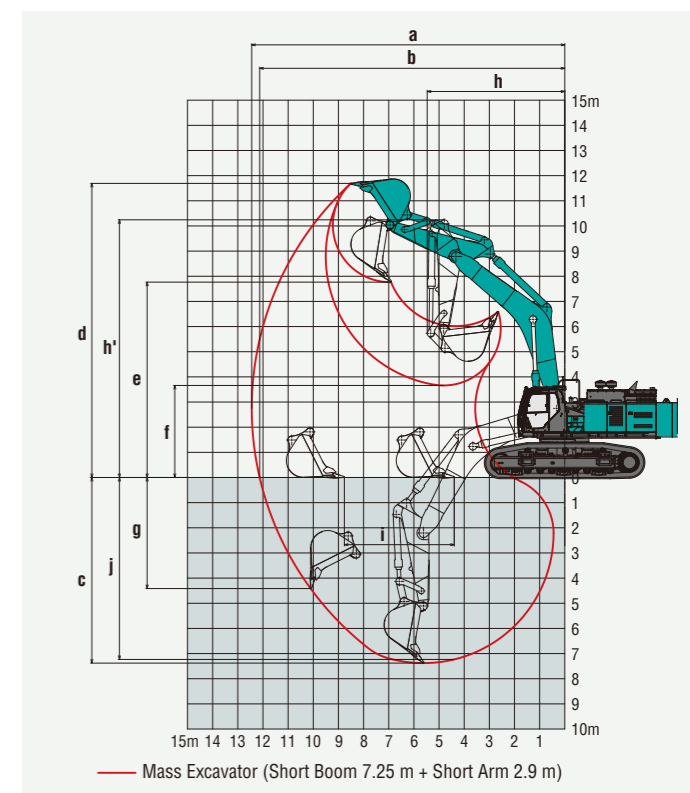

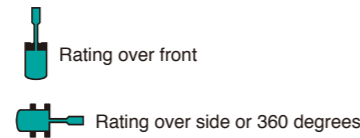
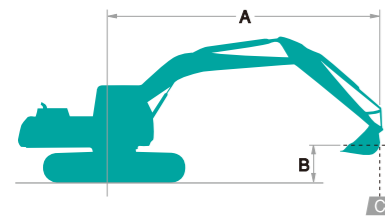

A - Reach from swing centerline to bucket hook
 B - Bucket hook height above/below ground
 C - Lifting capacities in kilograms
 • Relief valve setting: 33.0 MPa (337 kgf/cm²)

Mass Excavator Application

SK850LC		Boom: 7.25 m, Arm: 2.9 m Bucket: 5.1 m ³ ISO heaped 5,090 kg Shoe: 650 mm																
		3.0 m		4.5 m		6.0 m		7.5 m		9.0 m		10.5 m		At Max. Reach		Radius		
B	A	↑	↔	↑	↔	↑	↔	↑	↔	↑	↔	↑	↔	↑	↔			
9.0 m	kg															*10,400	*10,400	8.99 m
7.5 m	kg															*10,180	*10,180	9.89 m
6.0 m	kg															*12,760	*12,760	10.49 m
4.5 m	kg															*13,860	*13,860	10.85 m
3.0 m	kg															*15,040	*15,040	10.98 m
1.5 m	kg															*16,630	*16,630	10.90 m
G.L.	kg															*13,320	*13,320	10.61 m
-1.5 m	kg	*20,030	*20,030	*28,660	*28,660	*20,380	*20,380	*16,260	*16,260	*12,040	*12,040					*10,400	*10,400	8.99 m
-3.0 m	kg	*30,610	*30,610	*34,680	*34,680	*25,860	*25,860	*19,790	*19,790	*14,280	*14,280					*12,760	*12,760	10.49 m
-4.5 m	kg	*40,040	*40,040	*29,400	*29,400	*22,250	*22,250	*16,680	*16,680	*13,530	*13,530					*13,320	*13,320	10.61 m
-6.0 m	kg			*20,640	*20,640	*15,120	*15,120									*13,760	*13,760	6.34 m

SK850LC		Boom: 7.25 m, Arm: 2.9 m Bucket: 5.1 m ³ ISO heaped 5,090 kg Shoe: 750 mm																
		3.0 m		4.5 m		6.0 m		7.5 m		9.0 m		10.5 m		At Max. Reach		Radius		
B	A	↑	↔	↑	↔	↑	↔	↑	↔	↑	↔	↑	↔	↑	↔			
9.0 m	kg															*10,400	*10,400	8.99 m
7.5 m	kg															*10,180	*10,180	9.89 m
6.0 m	kg															*10,320	*10,320	10.49 m
4.5 m	kg															*13,860	*13,860	10.85 m
3.0 m	kg															*15,040	*15,040	10.98 m
1.5 m	kg															*16,630	*16,630	10.90 m
G.L.	kg															*13,320	*13,320	10.61 m
-1.5 m	kg	*20,030	*20,030	*28,660	*28,660	*20,380	*20,380	*16,260	*16,260	*12,040	*12,040					*10,400	*10,400	8.99 m
-3.0 m	kg	*30,610	*30,610	*34,680	*34,680	*25,860	*25,860	*19,790	*19,790	*14,280	*14,280					*12,760	*12,760	10.49 m
-4.5 m	kg	*40,040	*40,040	*29,400	*29,400	*22,250	*22,250	*16,680	*16,680	*13,530	*13,530					*13,320	*13,320	10.61 m
-6.0 m	kg			*20,640	*20,640	*15,120	*15,120									*13,760	*13,760	6.34 m

SK850LC		Boom: 7.25 m, Arm: 2.9 m Bucket: 4.3 m ³ ISO heaped 4,060 kg Shoe: 650 mm																
		3.0 m		4.5 m		6.0 m		7.5 m		9.0 m		10.5 m		At Max. Reach		Radius		
B	A	↑	↔	↑	↔	↑	↔	↑	↔	↑	↔	↑	↔	↑	↔			
9.0 m	kg															*11,120	*11,120	8.99 m
7.5 m	kg															*10,910	*10,910	9.89 m
6.0 m	kg															*11,080	*11,080	10.49 m
4.5 m	kg															*13,620	*13,620	10.85 m
3.0 m	kg															*14,740	*14,740	10.98 m
1.5 m	kg															*16,970	*16,970	10.90 m
G.L.	kg															*14,420	*14,420	10.61 m
-1.5 m	kg	*20,730	*20,730	*29,680	*29,680	*21,330	*21,330	*17,170	*17,170	*12,870	*12,870					*11,120	*11,120	8.99 m
-3.0 m	kg	*31,290	*31,290	*35,770	*35,770	*26,870	*26,870	*20,750	*20,750	*15,160	*15,160					*10,910	*10,910	9.89 m
-4.5 m	kg	*41,230	*41,230	*30,470	*30,470	*23,250	*23,250	*17,620	*17,620	*13,230	*13,230					*11,080	*11,080	10.49 m
-6.0 m	kg			*21,690	*21,690	*16,100	*16,100									*14,720	*14,720	6.34 m

SK850LC		Boom: 7.25 m, Arm: 2.9 m Bucket: 4.3 m ³ ISO heaped 4,060 kg Shoe: 750 mm																
		3.0 m		4.5 m		6.0 m		7.5 m		9.0 m		10.5 m		At Max. Reach		Radius		
B	A	↑	↔	↑	↔	↑	↔	↑	↔	↑	↔	↑	↔	↑	↔			
9.0 m	kg															*11,120	*11,120	8.99 m
7.5 m	kg															*10,910	*10,910	9.89 m
6.0 m	kg															*11,080	*11,080	10.49 m
4.5 m	kg															*13,620	*13,620	10.85 m
3.0 m	kg															*14,740	*14,740	10.98 m
1.5 m	kg															*16,970	*16,970	10.90 m
G.L.	kg															*14,420	*14,420	10.61 m
-1.5 m	kg	*20,730	*20,730	*29,680	*29,680	*21,330	*21,330	*17,170	*17,170	*12,870	*12,870					*11,120	*11,120	8.99 m
-3.0 m	kg	*31,290	*31,290	*35,770	*35,770	*26,870	*26,870	*20,750	*20,750	*15,160	*15,160					*10,910	*10,910	9.89 m
-4.5 m	kg	*41,230	*41,230	*30,470	*30,470	*23,250	*23,250	*17,620	*17,620	*13,230	*13,230					*11,080	*11,080	10.49 m
-6.0 m	kg			*21,690	*21,690	*16,100	*16,100									*14,720	*14,720	6.34 m

- Notes:**
- Do not attempt to lift or hold any load that is greater than these lift capacities at their specified lift point radius and heights. Weight of all accessories must be deducted from the above lift capacities.
 - Lift capacities are based on machine standing on level, firm, and uniform ground. User must make allowance for job conditions such as soft or uneven ground, out of level conditions, side loads, sudden stopping of loads, hazardous conditions, experience of personnel, etc.
 - Bucket lift hook defined as lift point.
 - The above lifting capacities are in compliance with ISO 10567. They do not exceed 87% of hydraulic lifting capacity or 75% of tipping load. Lifting capacities marked with an asterisk (*) are limited by hydraulic capacity rather than tipping load.
 - Operator should be fully acquainted with the Operator's and Maintenance Instructions before operating this machine. Rules for safe operation of equipment should be adhered to at all times.
 - Lift capacities apply to only machine as originally manufactured and normally equipped by KOBELCO CONSTRUCTION MACHINERY CO., LTD.

Transportation Plan

Configuration	Description	Total weight
<p>Transportation width: 3,400 mm</p>	Base machine without counterweight and bucket, with lower structure, 7.25 m Short Boom and 2.9 m short arm.	60,250 kg
<p>Transportation width: 3,400 mm</p>	Base machine without counterweight, bucket and arm, with lower structure and 7.25 m Short Boom.	56,020 kg
<p>Transportation width: 3,400 mm</p>	Base machine with lower structure, without counterweight, bucket, arm and boom.	45,980 kg
<p>Transportation width: 3,350 mm</p>	Base machine with carbody, without counterweight, bucket, arm, boom and lower structure.	21,040 kg

*Counterweight: 13,400 kg