



## CONSTRUCTION LOADALLS

531-70/535-95/533-105/535-125/535-140/540-140/540-170/541-70

Gross power: 63kW/58hp – 97kW/130hp, Lift capacity: 3100kg – 4100kg, Lift height: 7m – 16.7m



# JCB LOADALL: THE WORLD'S FAVOURITE TELEHANDLERS.

**Telescopic handlers are now one of the world's favourite construction vehicles, and no wonder; these versatile machines offer the best features of a mobile crane, wheel loader, and a forklift all in one efficient package. The combination of forward and vertical reach are simply unsurpassed by anything else on the site, meaning that you can place more materials in less time.**

JCB pioneered the very concept itself back in 1977, and remains market leader to this day. One reason for our success is that we are a company that manufactures a high percentage of our machines' componentry including engine, axles, rams, chassis' and booms. This means that a JCB telescopic handler is perfectly matched to our customers' requirements, our components are fully integrated and its levels of build quality are unsurpassed.

Our T2/3 JCB DIESELMAX engine, for example, is a highly productive unit that's designed to work in perfect harmony with our own full drivetrain. And we manufacture all of our own chassis' and booms, which means we can ensure the very highest levels of structural integrity to cope with the demands of the construction industry.

Through our worldwide dealer network you have a 'one stop shop' for parts and service and the service intervals of a JCB Loadall are extended and our maintenance procedures are simplified. Our telescopic handlers remain highly desirable long after their initial purchase. So much so that, throughout the world, JCB telescopic handlers can boast high residual values.

All of which means that if you want the most productive, the safest and the most efficient telescopic handler with the lowest possible cost of ownership, then you really only have one choice: a JCB Loadall.

## The world of the telehandler

- With a telehandler, you won't need to hire as much manpower
- A JCB Loadall has superior productivity due to its rough terrain and reach capabilities
- On-site traffic can be reduced, boosting safety.
- The versatility of the JCB telehandler means it can do the job of many machines





# ULTIMATE PERFORMANCE, **ULTIMATE PRODUCTIVITY.**

THE CONSTRUCTION LOADALL RANGE IS DESIGNED TO MAKE THE MOST EFFICIENT USE OF YOUR TIME AND MONEY. THAT MEANS YOU CAN EXPECT SUPERLATIVE PERFORMANCE, VERSATILITY, VISIBILITY, CYCLE TIMES AND ERGONOMICS. CLASS-LEADING PRODUCTIVITY IS, THEREFORE, A GIVEN.

## A productive machine.

1 A JCB Construction Loadall is extremely manoeuvrable making it easy to operate in confined spaces; the compact wheelbase and large steering lock angles save you valuable travel time on site.

2 Loadalls come with 4WD as standard (optional 2WD can also be selected to minimise tyre wear and fuel use when roading), helping you maintain plenty of traction and performance in soft, muddy areas. A limited slip differential in the front axle is an option too.\*

## Productive lifting and hydraulics.

3 JCB's optional Smoothride System (SRS)\* cushions shocks from the boom, improving load retention and increasing operator comfort (and therefore productivity) when travelling at speed on the road or on uneven fields.

\*Model dependant

The JCB Loadall construction range offers either a 63kw (85hp), 74kw (100hp) or a 97kw (130hp) DIESELMAX engine (model dependant), for optimal machine matching to the environment.

4 The JCB quickhitch system makes attachment-changing quick and easy.

5 For the most efficient lifting, extending and pushing – our class-leading hydraulics will give you the fastest cycle times.

On our three and four stage boom machines we fit stabilisers for increased stability and lift performance (not 535-95).

The JCB-built DIESELMAX engine produces its power and high torque at low engine speeds for great responsiveness, and our range of loadall models means you can find the perfect machine for your requirements, whether that be travelling on the road to handling material on site.





**Productive controls.**

**4** A Construction Loadall has three selectable steer modes. There's two wheel steer, which is ideal for travelling at high speed on the road; four-wheel steer for working in tight spaces; and crab steer for manoeuvring close to walls and buildings.

An optional reversing fan can be used to clear dust and debris from the cooling system to maintain performance.

**7** For added versatility, all JCB Loadalls are fitted as standard with a single boom auxiliary feature which can power a wide range of attachments.



## A SOUND INVESTMENT.

THE JCB LOADALL IS A HIGHLY VERSATILE MACHINE WITH ADDED DURABILITY, LIFT CAPACITIES OF UP TO 4,100KG, LIFT HEIGHTS OF UP TO 16.7M AND A WIDE RANGE OF ATTACHMENTS, THE JCB LOADALL CAN REPLACE THE NEED FOR HIRING EXTRA MACHINES SUCH AS CRANES, LOADING SHOVELS, FORK LIFT TRUCKS, SWEEPERS AND AERIAL WORK PLATFORMS. THE JCB LOADALL WILL BE THE ONLY MACHINE YOU NEED ON SITE.



By producing high levels of power and torque even at engine speeds as low as 1300-1400rpm, DIESELMAX can provide fuel-efficient matching of transmission and hydraulics.

### JCB DIESELMAX performance.

**1** The JCB DIESELMAX engine has been designed from scratch to give you performance you can depend on.

**2** It's an amazing piece of engineering, featuring an advanced combustion system that not only complies with Tier 3 Stage 3 emissions, but with future Tier 4/ Stage 4 compliance built into the engine design. So, with minimal installation changes required in the next decade, this engine is an excellent business investment for today and tomorrow.



**Further efficiency.**

3 A JCB Construction Loadall is a great asset in so many respects, not least financially – huge global demand, plus legendary productivity, plus superb build quality equals maximum resale value.

4 High back-off brakes on 531-70, 541-70, 535-95 and 533-105 reduce viscous drag during roading and rehandling, which improves fuel economy by up to 2%.

Lower Powershift oil levels deliver 1% fuel savings.



# THE STRONGEST CONTENDER.

IN ORDER TO BE TRULY EFFICIENT, OUR CONSTRUCTION LOADALLS ARE DESIGNED TO PROVIDE YOU WITH MAXIMUM UPTIME. TO DO THAT, WE BUILD OUR MACHINES TO BE AS TOUGH AS POSSIBLE, USING TOP QUALITY COMPONENTS AND INNOVATIVE MANUFACTURING PROCESSES. THIS, IN TURN, ENSURES MAXIMUM SERVICE LIFE.

## Tough boom design.

1 For ultimate strength and durability, we've built in large boom overlaps of more than 1.0m on all of our machines.

2 Hoses are routed through the boom for maximum protection.

## Built-in protection.

3 Bonnets on Construction Loadalls are protected from damage by being side-mounted on the chassis and recessed.

4 Our Construction Loadalls have fold-up rear lights that can be kept clear and well protected from on-site damage.

5 Opt for front and top screen roof guards for added protection from falling objects.

6 Heavy-duty axle feet help a Construction Loadall to absorb the stresses generated during material rehandling applications.

To protect our Construction Loadalls from corrosion over the long term, we dip the cab in electrophoretic alloy before painting it.

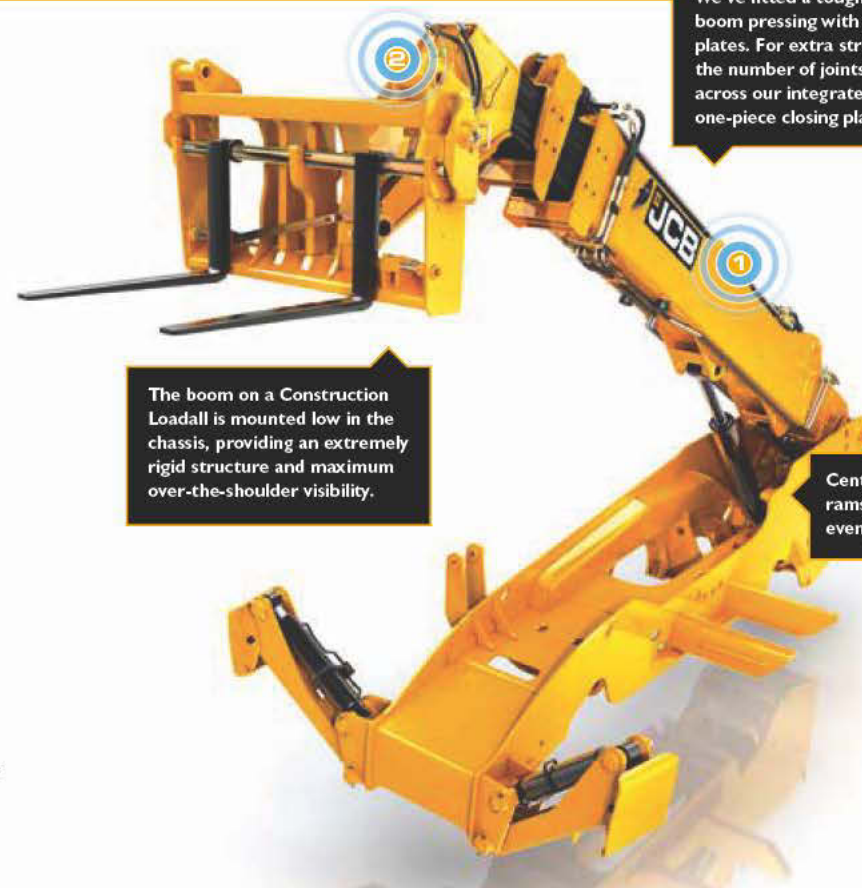

We've fitted a tough inverted U-shaped boom pressing with fully welded closing plates. For extra strength, we've reduced the number of joints and stress points across our integrated boom nose and one-piece closing plate.

The boom on a Construction Loadall is mounted low in the chassis, providing an extremely rigid structure and maximum over-the-shoulder visibility.

Centralised lift and displacement rams ensure load stresses are evenly distributed.



**Durable components.**

**7** The new Construction Loadall range's stringent testing programme has included prolonged high stress loading of the chassis, boom and other key components, as well as cold climate testing and repeated transmission use over thousands of cycles.

**8** The lift, tilt and extension rams are held in place by keyhole castings for even greater structural integrity.

**9** To prove how good our DIESELMAX engines are, we've tested them in 70 different machines across the toughest applications and environments.

**10** The one-piece fully welded chassis maximises strength and minimises weight.

**11** At JCB, we make our own hydraulic cylinders, cabs, axles, transmissions and engines – all designed to work in perfect harmony for optimum reliability.



11



7

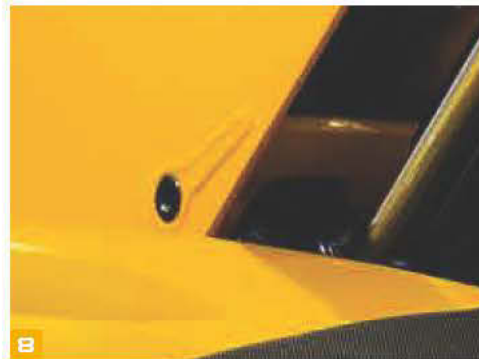

8



9



10

## A SLICK OPERATION.

JCB LOADALL OFFERS BEST-IN-CLASS COMFORT WITH: ONE OF THE LARGEST CABS IN THE INDUSTRY, CLASS-LEADING NOISE LEVELS, EXCELLENT AIRFLOW, VENTILATION AND DEMISTING, WITH OPTIONAL AIR CONDITIONING, AND A FULLY ADJUSTABLE SUSPENSION SEAT AND STEERING COLUMN FOR THE OPTIMUM DRIVING POSTURE. THE WHOLE POINT OF ANY CAB IS TO PUT THE OPERATOR IN CONTROL, AND JCB LOADALL DOES THIS WITH SIMPLICITY AND STYLE. ERGONOMIC, INTELLIGENT ARRANGEMENT OF ALL DIALS AND SWITCHES MAKES FOR INTUITIVE AND RELAXED OPERATION.



Simple to use twin manual levers and one manual auxiliary with optional single lever joystick.

### Ergonomic controls.

- 1 JCB cab offers a uniform airflow, hot or cold to the operator through 8 different vents generating a comfortable operator environment.
- 2 Backlit switches are crystal clear, even in the dark.
- 3 To create the perfect driving position, opt for the easily adjustable tilting telescopic steering column.



On bright days, a Construction Loadall's standard-fit tinted cab glass will reflect 30% of the sun's energy for enhanced operator comfort.



**Comfort and convenience.**

4 The optional cab, front, rear and boom work lights provide excellent visibility.

5 Visibility on a Construction Loadall is excellent, courtesy of direct glazing large roof screen and low profile bonnet.

In addition we have angled our roof bars to ensure maximum visibility when placing at height.

6 On our 540-170 Construction Loadalls we have fitted a servo joystick for fast and precise control (optional on a 535-140/535-125).

7 The exterior top door slam latch is new – you can now close the upper door from outside and hold the door ajar.



## SAFE AND SECURE.

A JCB CONSTRUCTION LOADALL CAN SAVE MORE THAN JUST TIME AND MONEY – IT CAN SAVE ITSELF AND ITS OPERATOR FROM POTENTIALLY DANGEROUS SITUATIONS. WE EQUIP OUR LOADALLS WITH STRINGENT SAFETY MEASURES TO PROTECT FROM ACCIDENTS, AS WELL AS EFFECTIVE SECURITY TECHNOLOGY TO GUARD AGAINST THEFT.

**1** For quick, easy and safe access, JCB Construction Loadalls have a three-point access and two cab steps.

**2** Hose burst check valves on the rams prevent collapse if a hose fails.

**3** A JCB Construction Loadall has excellent rearward and off-side visibility, courtesy of a low boom and bonnet profile and low boom pivot.

**4** A JCB Loadall comes equipped with a full set of side and rear view mirrors for all round visibility and safety compliance.

For extra safety, a reverse alarm is standard-fit on all construction Loadalls.

**5** JCB factory-fit immobilisers, can either be activated by a unique key or optional push button PIN system, that automatically arm themselves after a certain period following engine shutdown. LiveLink available in certain territories.



JCB Adaptive Load Control automatically controls hydraulic operation to help maintain the longitudinal stability of your Construction Loadall.



The operator presence switch on Construction Loadalls disables drive when an operator leaves their seat; this prevents accidental operation.



## LESS SERVICING, MORE SERVICE.

NATURALLY, YOU WANT YOUR CONSTRUCTION LOADALL TO SPEND AS MUCH TIME AS POSSIBLE AT WORK, NOT BEING WORKED ON. WHICH IS WHY JCB LOADALLS HAVE LONG SERVICE INTERVALS; AND, WHEN MAINTENANCE DOES NEED TO BE CARRIED OUT, YOU'LL FIND OUR MACHINES ARE EASY AND QUICK TO SERVICE.

**1** All daily checks, greasing and serviceable components can be accessed at ground level.

The filters on a Loadall (engine oil, hydraulic oil and fuel) are centrally located for fast, easy servicing. The air filter is easily accessible, and its double-element design simplifies cleaning. The fact that we design our Construction Loadalls to be fast and easy to service, ensures we have best-in-class SAE serviceability ratings.

**2** You can access a Construction Loadall's battery easily (and without specialist tools) via a lockable cover that's opened with the ignition key.

**3** The diesel tank is also easy to get to, and can be filled from ground level. For protection from dirty fuel, there's an integral pre-filter in the filler neck.

**4** A dry lubricant system means a Loadall's wear pads are extremely durable, with service intervals of 500 hours.



For fast, easy inspection of 3 sides of the engine, Construction Loadalls have a large, wide service bay, accessed by a gas-assisted bonnet.



# LIVELINK, WORK SMARTER.

**LIVELINK IS AN INNOVATIVE SOFTWARE SYSTEM THAT LETS YOU MANAGE JCB MACHINES REMOTELY – ONLINE, BY EMAIL OR BY MOBILE PHONE. ACCESS EVERYTHING FROM MACHINE ALERTS TO FUEL REPORTS AND HISTORY INFORMATION, WITH ALL DATA STORED AT A SECURE CENTRE.**

## Productivity and cost benefits

All LiveLink equipped Loadall machines built are now able to report fuel economy, idle time and engine load data through the LiveLink web portal, helping you reduce your fuel usage, saving you money and improving productivity. Machine location information can help improve efficiency and perhaps even reduce insurance costs.



## Maintenance benefits

Manage machine maintenance easily – accurate hours monitoring and service alerts improve maintenance planning, while real-time location data helps you manage your fleet. Critical machine alerts and maintenance history records are also available.



## Security benefits

LiveLink's real-time geofencing alerts tell you when machines move out of predetermined zones, and real-time curfew alerts inform you of unauthorised usage. Further benefits include real-time location information, advanced ECU matching (pairs LiveLink with the immobiliser or ECU).



## VALUE ADDED.

JCB'S WORLDWIDE CUSTOMER SUPPORT IS FIRST CLASS. WHATEVER YOU NEED AND WHEREVER YOU ARE, WE'LL BE AVAILABLE QUICKLY AND EFFICIENTLY TO HELP MAKE SURE YOUR MACHINERY IS PERFORMING TO ITS FULL POTENTIAL.



**1** Our Technical Support Service provides instant access to factory expertise, day or night, while our Finance and Insurance teams are always on hand to provide fast, flexible, competitive quotes.

**2** The global network of JCB Parts Centres is another model of efficiency; with 15 regional bases, we can deliver around 95% of all parts anywhere in the world within 24 hours. Our genuine JCB parts are designed to work in perfect harmony with your machine for optimum performance and productivity.



**3** JCB Assetcare offers comprehensive extended warranties and service agreements, as well as service-only or repair and maintenance contracts. Irrespective of what you opt for, our maintenance teams around the world charge competitive labour rates, and offer non-obligation quotations as well as fast, efficient insurance repair work.

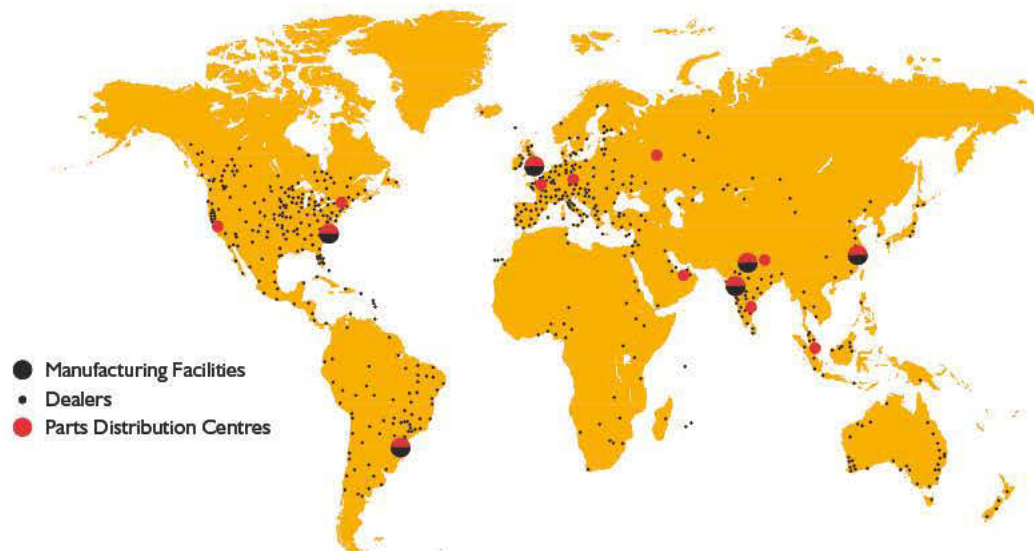

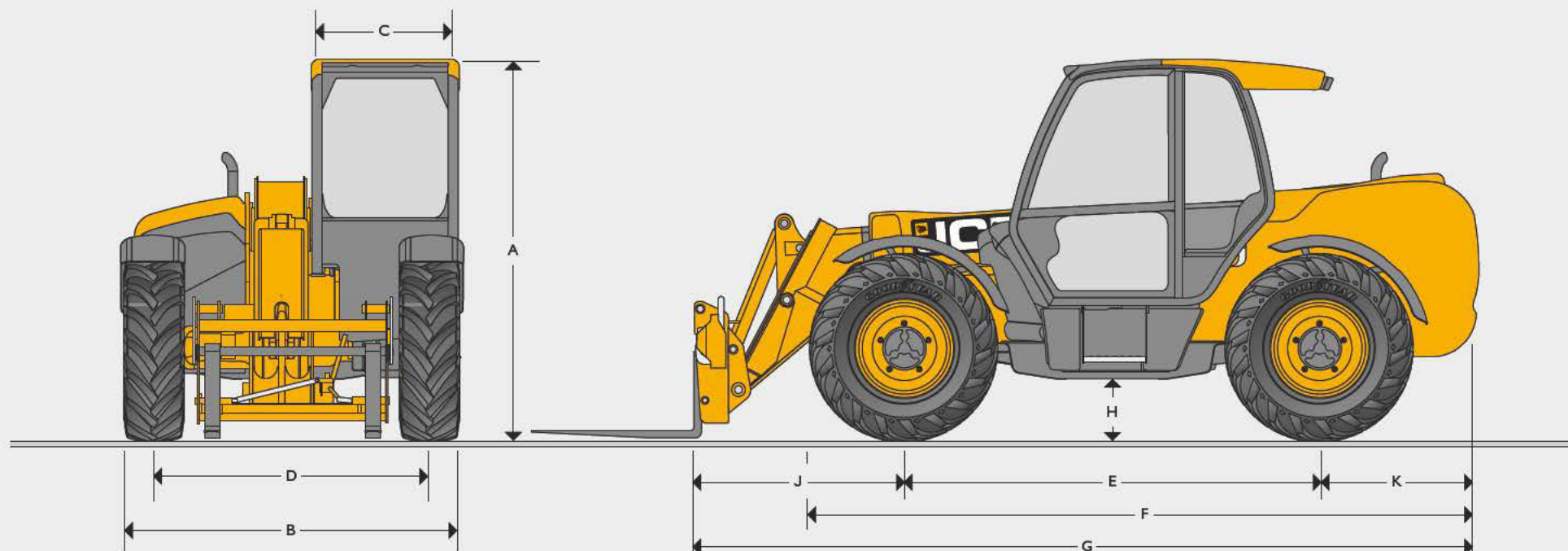

STATIC DIMENSIONS									
Machine model		531-70	541-70	535-95	533-105	535-125 HiViz	535-140 HiViz	540-140	540-170
A	Overall height	m	2.49	2.49	2.49	2.49	2.59	2.59	2.69
B	Overall width (over tyres)*	m	2.23	2.23	2.36	2.36	2.35	2.35	2.44
C	Inside width of cab	m	0.94	0.94	0.94	0.94	0.94	0.94	0.94
D	Front track	m	1.81	1.81	1.87	1.87	1.90	1.90	1.90
E	Wheelbase	m	2.75	2.75	2.75	2.75	2.75	2.90	2.75
F	Overall length to front tyres	m	4.38	4.38	4.38	4.38	4.74	4.74	5.08
G	Overall length to front carriage	m	4.99	4.99	4.99	5.38	5.80	6.23	6.36
H	Ground clearance	m	0.40	0.40	0.40	0.40	0.40	0.40	0.40
J	Front wheel centre to carriage	m	1.25	1.25	1.20	1.62	1.68	2.11	1.94
K	Rear wheel centre to rear face	m	0.99	0.99	1.04	1.01	1.37	1.37	1.67
	Overall width with stabilisers fully deployed	m	NA	NA	NA	2.63	2.57	2.73	3.55
	Outside turn radius (over tyres)	m	3.7	3.7	3.7	3.7	3.75	4.10	4.10
	Carriage rollback angle	degrees	42.6	42.6	41.0	41.2	37.0	37.0	39
	Carriage dump angle	degrees	37.5	37.5	24.0	24.0	12.5	12.5	8.8
	Weight	kg	7060	7850	8215	8850	9720	10880	12060
	Tyres		15.5/80-24	15.5/80-24	15.5/80-24	15.5/80-24	15.5/80-24	15.5/80-24	15.5/80-24

\* Type Dependent

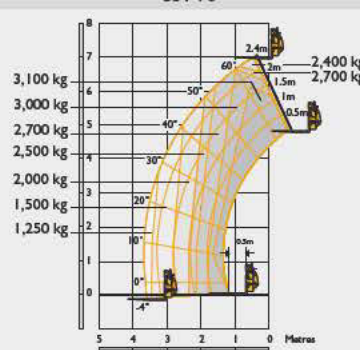
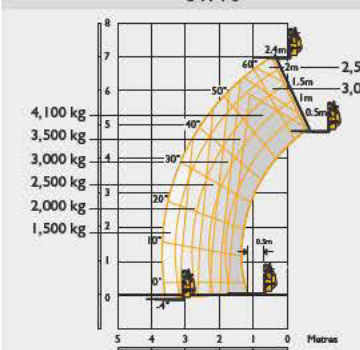
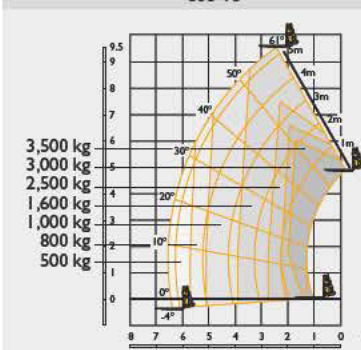

LIFT PERFORMANCE

		531-70	541-70	535-95
				
Maximum lift capacity	kg	3170	4100	3500
Lift capacity to full height	kg	2400	2500	1600
Lift capacity at full reach	kg	1250	1500	500
Lift height	m	7.0	7.0	9.50
Reach at maximum lift height	m	0.48	2.94	2.43
Maximum forward reach	m	3.7	3.7	6.52
Reach with 1 tonne load	m	3.7	3.7	5.08
Placing height	m	6.3	6.3	8.78

Complies with stability test EN 1459 Annex B.

LIFT PERFORMANCE

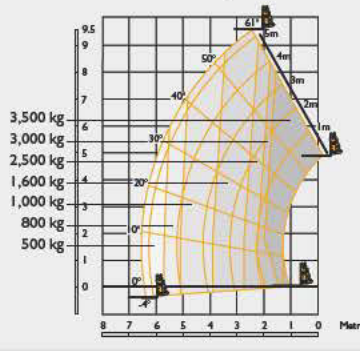
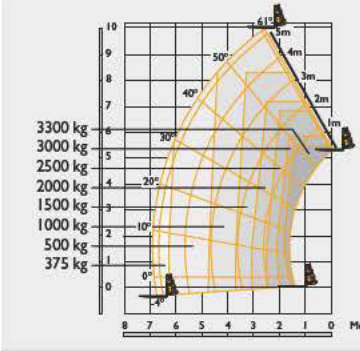
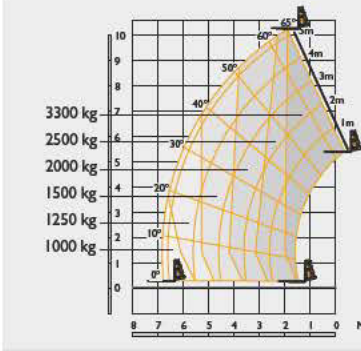
		535-95 Sway	533-105 Stabilisers retracted	533-105 Stabilisers extended
				
Maximum lift capacity	kg	3500	3300	3300
Lift capacity to full height	kg	1600	1000	3300
Lift capacity at full reach	kg	500	375	1000
Lift height	m	9.50	9.85	10.22
Reach at maximum lift height	m	2.43	2.63	1.91
Maximum forward reach	m	6.52	6.91	6.83
Reach with 1 tonne load	m	5.08	4.83	6.83
Placing height	m	8.78	9.44	9.82

Complies with stability test EN 1459 Annex B.

LIFT PERFORMANCE

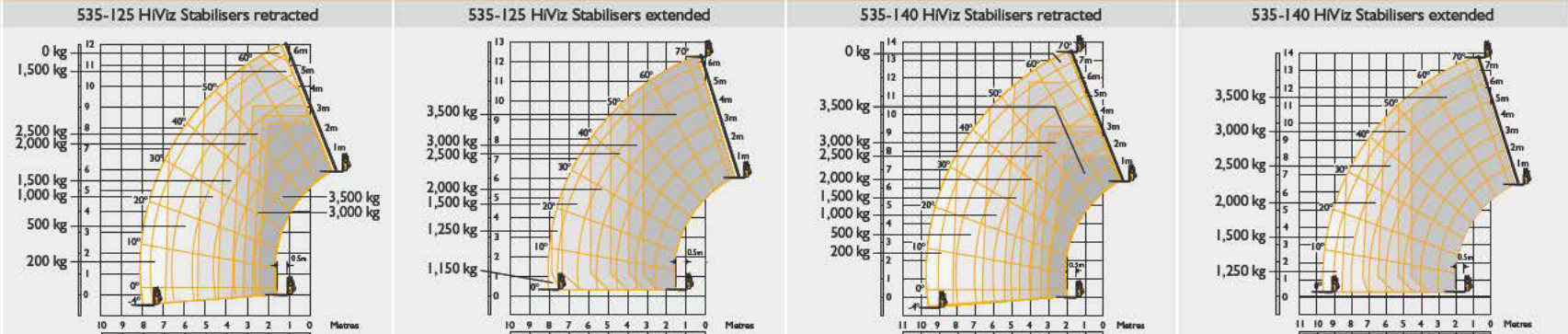

Maximum lift capacity	kg	3500	3500	3500	3500
Lift capacity to full height	kg	1500	3500	1500	3000
Lift capacity at full reach	kg	200	1150	200	1250
Lift height	m	12.28	12.07	13.78	13.78
Reach at maximum lift height	m	1.36	0.46	1.94	0.93
Maximum forward reach	m	8.10	8.06	9.70	9.60
Reach with 1 tonne load	m	5.31	8.06	6.61	9.60
Placing height	m	11.43	11.75	13.02	13.30

Complies with stability test EN 1459 Annex B. Chassis Levelling (Sway) with stabilisers retracted (Sway angle ±9°).

LIFT PERFORMANCE

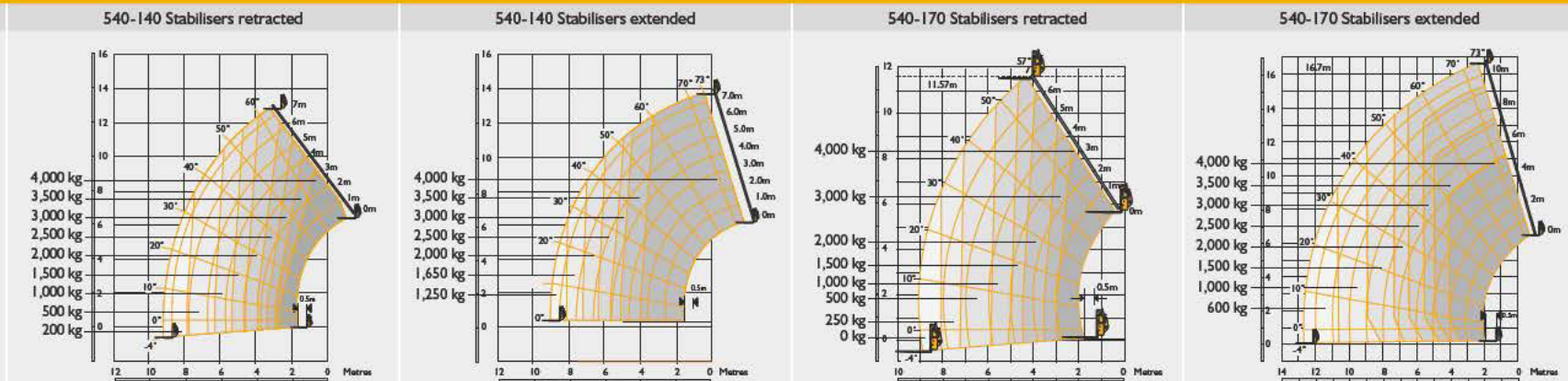

Maximum lift capacity	kg	4000	4000	4000	4000
Lift capacity to full height	kg	2000	4000	1500	2500
Lift capacity at full reach	kg	200	1250	0	600
Lift height	m	12.82	13.8	11.57	16.7
Reach at maximum lift height	m	2.94	0.74	4.15	2.05
Maximum forward reach	m	9.25	9.25	9.04	12.50
Reach with 1 tonne load	m	6.25	9.25	5.76	10.50
Placing height	m	12.25	13.25	10.90	16.20

Complies with stability test EN 1459 Annex B.

ENGINE								
	531-70	541-70	535-95	533-105	535-125 HiViz	535-140 HiViz	540-140	540-170
Engine 63kW (58hp) @ 2200rpm, 400Nm torque at 1300rpm	Standard	Standard	Standard	Standard	Standard	Standard	Standard	N/A
Engine 74kW (100hp) @ 2200rpm, 512Nm torque at 1300rpm	Option	Option	Option	Option	Option	Option	Option	Standard
Engine 97kW (130hp) @ 2200rpm, 550Nm torque at 1300rpm	Option	Option	Option	Option	Option	Option	Option	Option

HYDRAULIC CYCLE TIMES								
	531-70	541-70	535-95	533-105	535-125 HiViz	535-140 HiViz	540-140	540-170
Boom raise	s	7.2	8.8	9.1	8.8	10.4	13.5	22.7
Boom lower	s	5.4	6.5	7.7	8.5	8.1	11	23.4
Extend	s	6.8	6.8	10.5	13.2	15.7	19.5	18.3
Retract	s	5	5	11.2	13.6	12.8	14.4	16.7
Bucket dump	s	3.5	3.5	2.4	2.4	1.8	3.2	4.2
Bucket crowd	s	2.9	2.9	3.5	3.4	2.3	2.5	4.6

HYDRAULICS		
	Hydraulic System Pressure (bar)	Max. Pump flow (litres)
531-70	241	82
541-70	260	82
550-80	260	140
535-95	241	82
533-105	241	82
535-125	260	260
535-140	110	110
540-140	241	103
540-170	260	90+72

<b>TRANSMISSION</b>	Torque converter, 4 speed powershift gearbox. Travel speed 531-70/541-70/535-95/533-105: 29kph, 33kph (when 2/4WD select is specified). Travel speed 535-125/535-140 540-140/540-170: 29kph. Optional 33kph transmission.
<b>BRAKING</b>	Service brake: Servo-assisted, hydraulically oil-immersed multi-disc on front and rear axle. Parking brake: Hand operated disc brake on output of gearbox. (97kW/130hp – oil immersed disc type).
<b>CAB</b>	Conforms to ROPS ISO 3471 and FOPS ISO 3449
<b>OPTIONS</b>	Front and rear working lights, rotating flashing beacon, fire extinguisher, traction and industrial tyres, electrical 2/4WD select, limited slip differential in front axle, windscreen and roof guard, air suspension seat, deluxe cab trim, roof and front screen blind, radio kit, air conditioning, reversing fan, deluxe trim, armrest (SLC only), roof moulding, single lever control (model dependant). Single lever mechanical joystick, with push button extend and retract.



**ONE COMPANY, OVER 300 MACHINES.**

Your nearest JCB dealer

**Construction Loadalls 531-70/535-95/533-105/535-125/535-140/540-140/540-170/541-70**

Gross power: 63kW/58hp – 97kW/130hp Lift capacity: 3100kg – 4100kg

Lift height: 7m – 16.7m Bucket capacity: 0.265 – 0.995m<sup>3</sup>

JCB Sales Limited, Rokeceter, Staffordshire, United Kingdom ST14 5JP.

Tel: +44 (0)1889 590312 Email: [salesinfo@jcb.com](mailto:salesinfo@jcb.com)

Download the very latest information on this product range at: [www.jcb.com](http://www.jcb.com)

© 2009 JCB Sales. All rights reserved. No part of this publication may be reproduced, stored in a retrieval system, or transmitted in any form or by any other means, electronic, mechanical, photocopying or otherwise, without prior permission from JCB Sales. All references in this publication to operating weights, sizes, capacities and other performance measurements are provided for guidance only and may vary dependant upon the exact specification of machine. They should not therefore be relied upon in relation to suitability for a particular application. Guidance and advice should always be sought from your JCB Dealer. JCB reserves the right to change specifications without notice. Illustrations and specifications shown may include optional equipment and accessories. The JCB logo is a registered trademark of J.C. Bamford Excavators Ltd.



9999/5776 09/14 en-GB Issue 1 (T3)

